

*Stoiki do kremów kosmetycznych / jars for cosmetic creams*

*Pojemniki specjalne / containers*

*Butelki / bottles*

*Pudełka apteczne / pharmaceutical containers*





## O firmie

**Firma Polipack od 24 lat specjalizuje się w produkcji wysokiej jakości opakowań z polipropylenu, polistyrenu i polietylenu do wyrobów kosmetycznych oraz farmaceutycznych o pojemności od 5ml do 8l. Wychodząc naprzeciw oczekiwaniom klientów, uruchomiliśmy też nową technologię przetwórstwa tworzywa PET. Nasze przedsiębiorstwo charakteryzuje się wysoką dynamiką rozwoju. Posiadamy rozwinięty park maszynowy umożliwiający realizację złożonych projektów.**

Produkujemy na nowoczesnych urządzeniach. Nasze opakowania wykonujemy zarówno według własnych wzorów jak i indywidualnych zamówień klienta, wykorzystując formy własne i powierzone. Co roku poszerzamy ofertę naszej firmy o nowe wzory opakowań. Wspomniany park maszynowy umożliwia nam wykonywanie nadruków metodą sitodruku i tampodruku wielobarwnego oraz wtop na gorąco foliami na powierzchniach płaskich, cylindrycznych i owalnych w zakresie wszystkich oferowanych przez nas opakowań. Dzięki zdobieniu Twój produkt wyróżni się spośród innych, będzie łatwo zauważalny, identyfikowalny i efektowny.

Posiadamy Certyfikat Systemu Jakości ISO 9001:2008 oraz Certyfikat Zarządzania Środowiskowego ISO 14001:2004. Pragniemy, aby nazwa Polipack była zawsze dla naszych klientów synonimem najwyższej jakości produktu.

Konsekwentnie realizujemy wizję rozwoju firmy wyrażającą się w hasle: **OPAKOWANIE WSPÓŁTWORZY PRODUKT.**

## About Polipack

We have been specializing in the manufacture of high quality PP, PS and PE packaging for cosmetics and pharmaceuticals for 24 years, in volumes ranging from 5 ml to 8 l. Trying to meet our customer's expectations we implemented new technological line for PET processing. Our company is developing dynamically and we have an advanced stock of machines enabling us to carry out complex projects.

Our modern equipment is central to our manufacturing processes. Our packaging is made both according to our own designs and according to our customers' individual orders — we also use both our own and entrusted moulds. New packaging designs are introduced every year. Our machine stock enables us also to provide overprints prepared using screen printing and multi-colour pad printing methods, as well as hot fusion film inlays on flat, cylindrical and oval surfaces on all the packaging we offer. Thanks to our decorations, your product will stand out from the rest – it will be easily distinguishable, identifiable and original.

We possess the ISO 9001:2008 Quality System Certificate and ISO 14001:2004 Environmental System Certificate. Our wish is for the Polipack brand to be a synonym of the highest quality for our customers.

Consistently we realize the vision of the business progress manifesting itself in the motto : **THE PACKAGING CO-CREATES THE PRODUCT.**



## Spis treści:

- Słoiki do kremów kosmetycznych / Jars for cosmetic creams 3-25
- Pudełka apteczne / Pharmaceutical containers 27-33
- Pojemniki specjalne / Containers 35-37
- Butelki / Bottles 39-41
- Miarki / Measures 43-44
- Przekładki / Liners 45-46



**słoiki do kremów kosmetycznych**  
/jars for cosmetic creams

TYP I



50ml



75ml



100ml



100ml



200ml



300ml

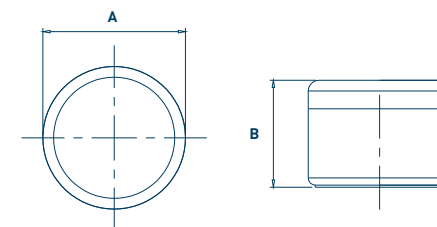

Pojemność [ml] Capacity	Materiał Material	A	B
50	PP	Ø68	32,4
75	PP	Ø68	38,4
100	PP	Ø68	45,4
100	PP	Ø90,2	33,1
200	PP	Ø90,2	55,7
300	PP	Ø90,2	72,5

\*Istnieje możliwość wykonania stoika w wersji matowej lub błyszczącej / There is the possibility to produce the jar in matte or shiny version

\*\*Istnieje możliwość zastosowania przekładki PP / There is the possibility to use the PP Liner



**TYP II**



5ml

**TYP IIA**



5ml



10ml

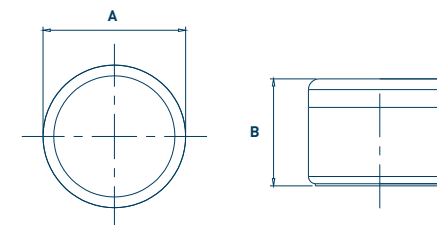

Pojemność[ml] Capacity	Materiał Material	A	B
5	PS	Ø27,5	21,2
5	SAN	Ø27,5	21,2
5	PP	Ø30,1	20,8
5	PP/SAN	Ø30,1	20,8
10	PP	Ø30,1	27,4
10	PP/SAN	Ø30,1	27,4



**TYP III**



**TYP III A**

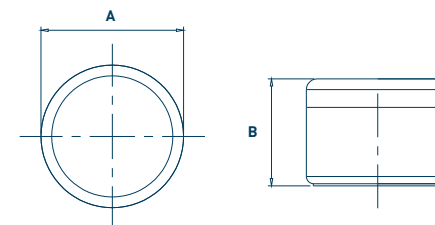

Pojemność[ml] Capacity	Materiał Material	A	B
10	SAN	Ø37,1	19,7
20	SAN	Ø42,5	31,3
30	SAN	Ø56,5	32,7
50W	SAN	Ø56,5	49,6
50N	SAN	Ø56,5	39,7
170	SAN/PP	Ø80	59,4

\*Istnieje możliwość zastosowania przekładki PP / There is the possibility to use the PP Liner





5ml



10ml



15ml



30ml N5



30ml W N5



50ml N5



50ml W N5



100ml



150ml

TYP IV

\*Istnieje możliwość zastosowania przekładki PP / There is the possibility to use the PP Liner

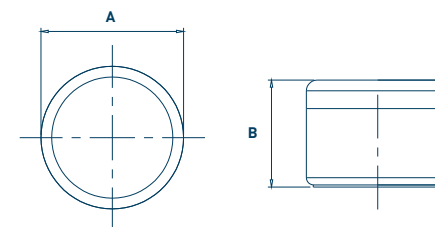

Pojemność [ml] Capacity	Materiał Material	A	B
5	PP	Ø33,8	30,5
5	SAN/PP	Ø33,9	30,8
10	PS/PP	Ø42,6	37,8
10	PP	Ø43,4	38,7
10	SAN/PP	Ø42,6	37,8
15	PS/PP	Ø42,6	37,5
15	PP	Ø43,4	38,4
15	SAN/PP	Ø42,6	37,5
30 N N5	PS/PP	Ø56,8	46,8
30 W N5	PS/PP	Ø56,8	51
50 N N5	PS/PP	Ø56,8	46,4
50 W N5	PS/PP	Ø56,8	51,2
100	PS/PP	Ø79,7	45,7
150	PP	Ø78,7	60,2

TYP XII



50ml



100ml



165ml



270ml

\*Istnieje możliwość zastosowania przekładki PP / There is the possibility to use the PP Liner

\*\*Istnieje możliwość wykonania nakrętek w wersji matowej do poj. 165ml i 270ml / There is the possibility to use the matte cap for 165ml and 270ml jars

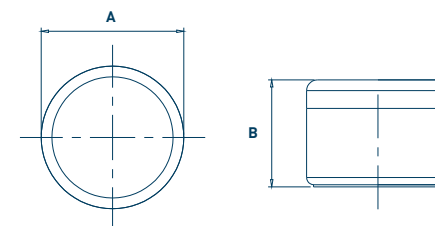

Pojemność[ml] Capacity	Materiał Material	A	B
50	PP	Ø75,4	34,6
100	PP	Ø75,4	41,6
165	PP	Ø90,2	46,7
270	PP	Ø90,2	63



TYP XIII



50ml

TYP XIII A



10ml



15ml



50ml



300ml

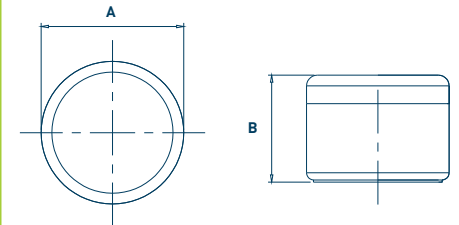

Pojemność [ml] Capacity	Materiał Material	A	B
50	PP	Ø68,1	52,4
10	PP	Ø46,5	36,7
15	PP	Ø46,5	36,4
50	PP	Ø68,1	53
300	PP	Ø104,8	82,5

\*Istnieje możliwość zastosowania przekładki PP / There is the possibility to use the PP Liner



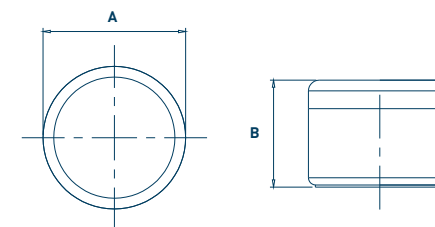
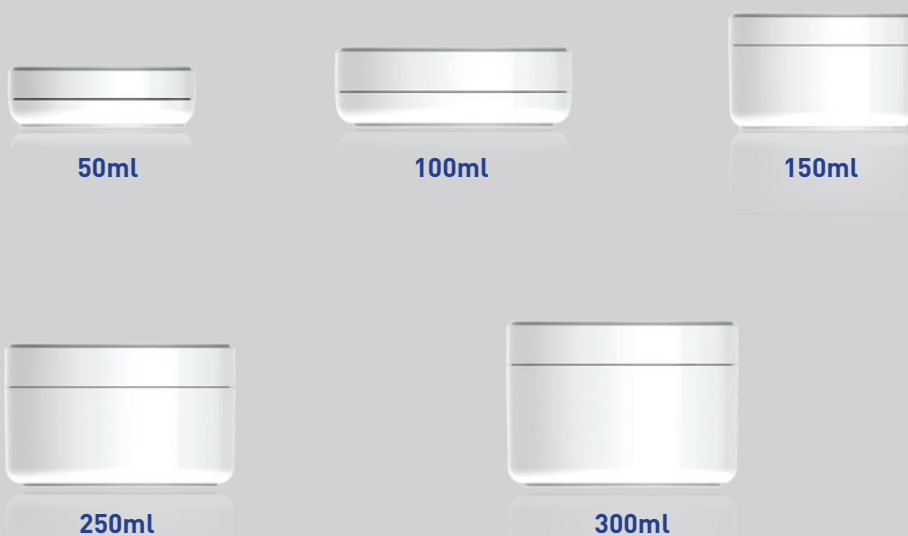

Pojemność[ml] Capacity	Materiał Material	A	B
50	PP	Ø75,4	24,6
100	PP	Ø90,2	30,3
150	PP	Ø75,4	46,6
250	PP	Ø90,2	56,1
300	PP	Ø90,2	63,9

\*Istnieje możliwość zastosowania przekładki PP / There is the possibility to use the PP Liner.

\*\*Istnieje możliwość wykonania nakrętek w wersji matowej do poj. 100ml, 250ml i 300ml / There is the possibility to use the matte cap for 100ml, 250ml and 300ml jars



**TYP XV B**



50ml



165ml



270ml

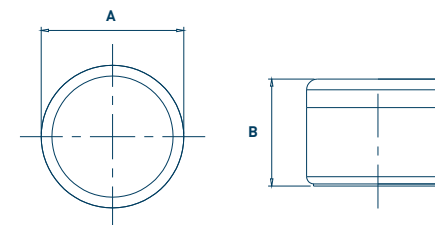

Pojemność [ml] Capacity	Materiał Material	A	B
50	PP	Ø64,9	54
165	PP	Ø90,2	51,8
270	PP	Ø90,2	73,4

TYP XVIII



50ml

\*Istnieje możliwość zastosowania przekładki PP / There is the possibility to use the PP Liner

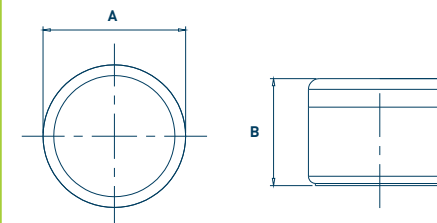

Pojemność[ml] Capacity	Materiał Material	A	B
50	PS/PP	Ø59,9	56,2

/// Stoik TYP XVIII z termosem / S-Type XVIII ///

TYP XIX

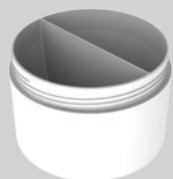

2x125ml

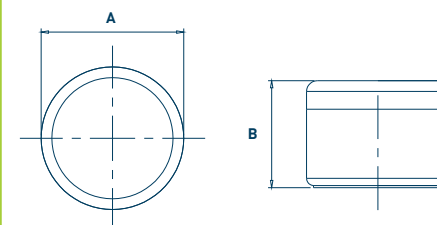

Pojemność[ml] Capacity	Materiał Material	A	B
2x125	PP	Ø90,2	63

/// Stoik TYP XIX z termosem 2-komorowy / S-Type XIX ///

**TYP XX**



**100ml**



**250ml**



**300ml**

\*Istnieje możliwość zastosowania przekładki PP / There is the possibility to use the PP Liner

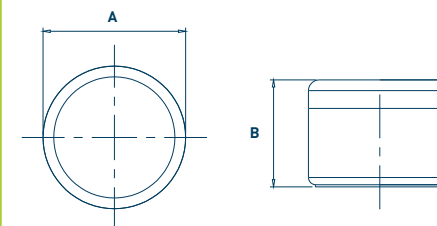

Pojemność [ml] Capacity	Materiał Material	A	B
100	PP	Ø90,2	35,2
250	PP	Ø90,2	61,2
300	PP	Ø90,2	69,3



TYP XXI



\*Istnieje możliwość zastosowania przekładki PP / There is the possibility to use the PP Liner

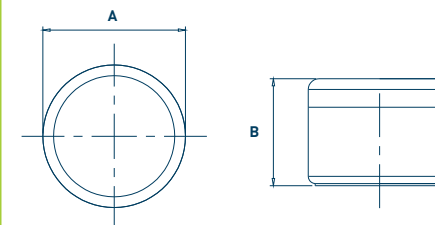

Pojemność [ml] Capacity	Materiał Material	A	B
200	PP	Ø96,4	70,4

TYP XXII



200ml

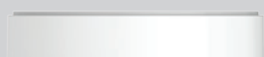

N TYP XII/XIV



300ml

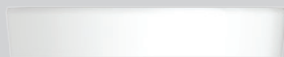

N TYP XIII A



500ml



N TYP XV B

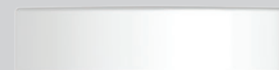

N TYP XXI

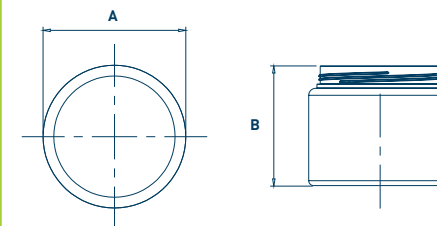

Pojemność [ml] Capacity	Materiał Material	A	B
200	PET/PP	Ø102	45,8
300	PET/PP	Ø101,8	58,1
500	PET/PP	Ø102,2	85,6

\*Istnieje możliwość zastosowania przekładki PP / There is the possibility to use the PP Liner

\*\*Istnieje możliwość zastosowania nakrętek Typ XII/XIV, Typ XIII A, Typ XV B, Typ XXI / There is the possibility to use the caps Type XII/XIV, Type XIII A, Type XV B, Type XXI

TYP XXIII

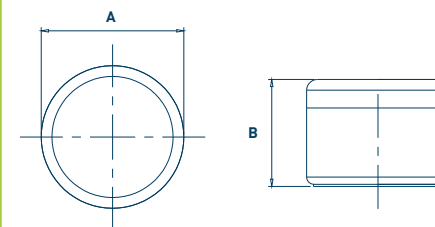

Pojemność [ml] Capacity	Materiał Material	A	B
200	PET/PP	Ø104	43,3
300	PET/PP	Ø104	52,3
500	PET/PP	Ø104	78,3
1000	PET/PP	Ø104	141,8





TYP XXIV



200ml



300ml



500ml

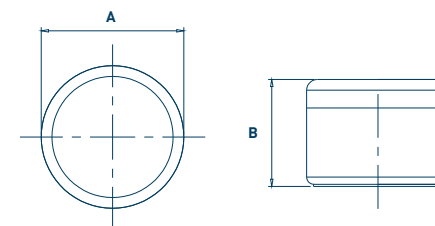

Pojemność [ml] Capacity	Materiał Material	A	B
200	PET/PP	Ø90,2	62,8
300	PET/PP	Ø90,2	77,3
500	PET/PP	Ø90,2	108,4

TYP XXV



500ml

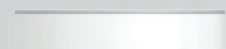

N TYP XII/XIV

\*Istnieje możliwość zastosowania nakrętki Typ XII/XIV  
 / There is the possibility to use the cap Type XII/XIV

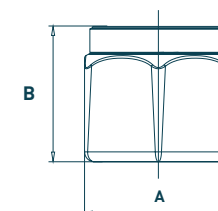
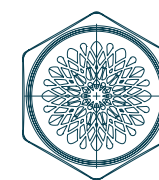

Pojemność[ml] Capacity	Materiał Material	A	B
500	PET/PP	Ø110,8	91,5





**pudełka apteczne**  
/ pharmaceutical containers



50ml



65ml



125ml



175ml

TYP VI

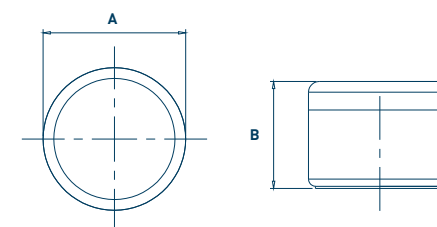

Pojemność[ml] Capacity	Materiał Material	A	B
50/30g	PP	Ø57,5	29,3
65/50g	PP	Ø57,5	36
125/100g	PP	Ø82	34,3
175/150g	PP	Ø82	45,5



45ml



75ml



100ml



150ml



220ml

TYP VII

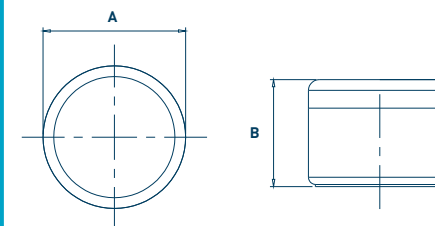

Pojemność [ml] Capacity	Materiał Material	A	B
45/30g	PP	Ø60,4	26
75/50g	PP	Ø60,4	37,6
100/85g	PP	Ø80	33,6
150/125g	PP	Ø80	44
220/200g	PP	Ø80	60,6



50ml



75ml



100ml



125ml



170ml



250ml N



250ml W



500ml

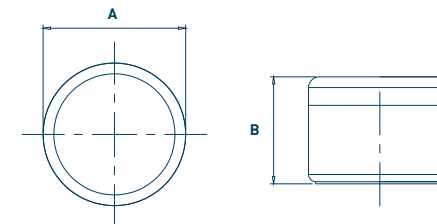

Pojemność[ml] Capacity	Materiał Material	A	B
50/30g	PP/PE	Ø57	32,5
75/50g	PP/PE	Ø57	44
100/75g	PP/PE	Ø57	56,9
125/100g	PP/PE	Ø57	69,9
170/150g	PP/PE	Ø81	42,8
250/220g N	PP/PE	Ø81	64
250/220g W	PP/PE	Ø57	135,2
500/450g	PP/PE	Ø81	123,7



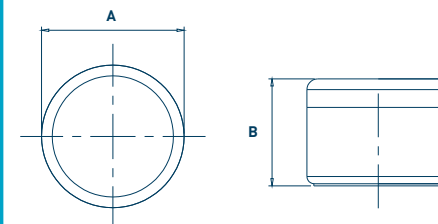

TYP XI



30ml 50ml N 50ml W 75ml 100ml 150ml 200ml



300ml 450ml 500ml 600ml 1000ml 1500ml 2000ml



300ml 450ml 500ml 600ml 1000ml

TYP XI A



1500ml 2000ml 3500ml 5000ml 6500ml 8000ml

Pojemność[ml] Capacity	Materiał Material	A	B
30	PE	Ø36,1	53,2
50 N	PE	Ø52,9	53,8
50 W	PE	Ø36,1	75
75	PE	Ø52,9	66,2
100	PE	Ø53	80
150	PE	Ø53	105,8
200	PE	Ø53	132
300	PE	Ø81	81,2
450	PE	Ø81	117,2
500	PE	Ø101	108
600	PE	Ø81	149
1000	PE	Ø101	157
1500	PE	Ø122	174,5
2000	PE	Ø122	221,5
300	PE	Ø80	81,9
450	PE	Ø80	118,5
500	PE	Ø101	109
600	PE	Ø80	149,1
1000	PE	Ø101	157,2
1500	PE	Ø122	176,1
2000	PE	Ø122	224,1
3500	PE	Ø193	172,5
5000	PE	Ø193	231,5
6500	PE	Ø193	289,1
8000	PE	Ø193	336,5





5ml



15ml



25ml



40ml



60ml



125ml



185ml



250ml



310ml



350ml



600ml



650ml



750ml



1200ml

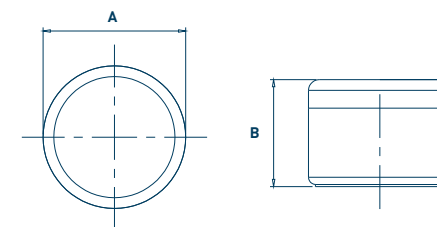

Pojemność[ml] Capacity	Materiał Material	A	B
5/3g	PP	Ø34,4	12,7
15/10g	PP	Ø34,4	27,5
25/20g	PP	Ø34,4	41,5
40/30g	PP	Ø56,5	27,8
60/50g	PP	Ø56,5	35,6
125/100g	PP	Ø80,3	36,5
185/150g	PP	Ø80,3	52
250/200g	PP	Ø108,5	42,4
310/250g	PP	Ø80,3	82,9
350/300g	PP/PE	Ø119	51,7
600/500g	PP	Ø108,8	83,5
650/550g	PP/PE	Ø119	83,6
750/700g	PP/PE	Ø119	103,5
1200/1000g	PP/PE	Ø119	156,5

\*Istnieje możliwość zastosowania przekładki PP lub wargi uszczelniającej / There is the possibility to use the PP Liner or cap with tight lip

TYP XVI



**pojemniki specjalne**  
**/ containers**

TYP PI

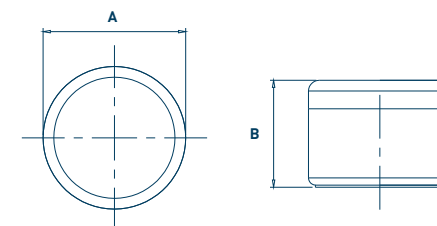

Pojemność [ml] Capacity	Materiał Material	A	B
300/0,25kg	PE/PP	Ø121,5	45,5
700/0,5kg	PE/PP	Ø121,5	93,8
1200/1kg	PE/PP	Ø121,5	167

TYP XVII



450ml



600ml

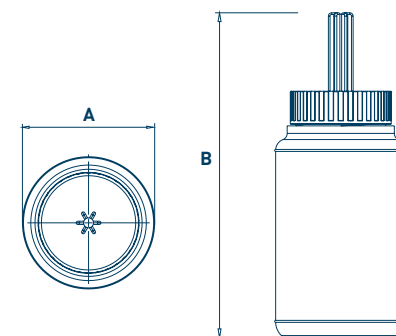

Pojemność [ml] Capacity	Materiał Material	A	B
450	PE/PP	Ø81	164
600	PE/PP	Ø81	195,8





**butelki / bottles**

**TYP V PET**

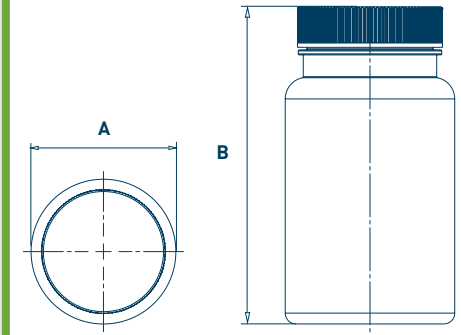

Pojemność [ml] Capacity	Materiał Material	A	B
60	PET	Ø38,4	70,4
75	PET	Ø42	82,6
75	PET/PP	Ø45,2	83,5
100	PET/PP	Ø47	88,2
120	PET/PP	Ø49	95
150	PET/PP	Ø50	107,2
175	PET/PP	Ø56,6	98,6
200	PET/PP	Ø58,4	113,1
250	PET/PP	Ø63,6	114
300	PET/PP	Ø69,1	115,6
400	PET/PP	Ø73	131,1
500	PET/PP	Ø77,6	141,1

\*W nakrętce zastosowano przekładkę PS / There is the liner PS in the cap





**miarki / measures**

**TYP I**



**TYP II**



**TYP III**

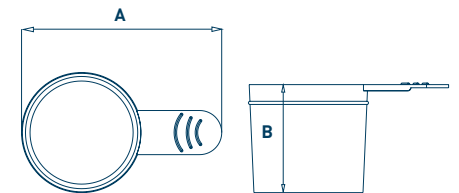
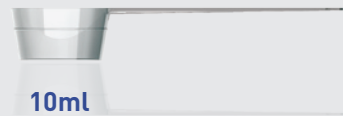

Pojemność[ml] Capacity	Materiał Material	A	B
5/10/15/20	PP	63,6	26,1
25	PP	63	34,6
5/10/15/20	PP	95,4	26,8
10/20/30/40/50	PP	164	39,8
10	PP	94,4	16,6
10	PP	128,4	16,6

**przekładki PP**  
/ PP liners



5ml



10/15ml



30/50ml



100/300ml

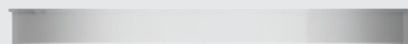

250/600ml

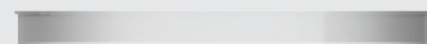
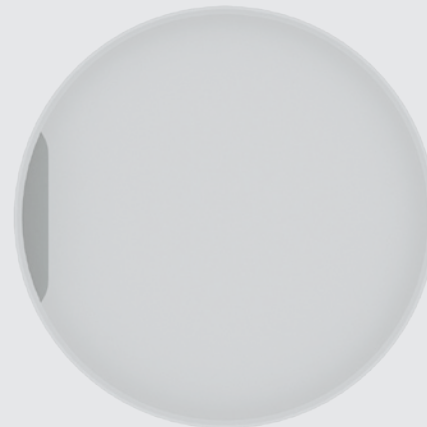

750/1200ml

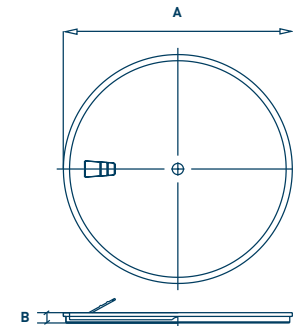

Pojemność[ml] Capacity	Materiał Material	A	B
5	PP	Ø29,1	2
10/15	PP	Ø38	2,4
30/50	PP	Ø49	3,9
100-300	PP	Ø85,6	3,9
250/600	PP	Ø102,5	8,7
750/1200	PP	Ø111	9,2





### Projekt Opakowania

Masz produkt, na którego stworzenie poświęcono dużo czasu, uwagi oraz środków. Produkt jest unikalny i wyjątkowy. Jednak **pierwszą rzeczą, którą zobaczy Twój Klient będzie opakowanie**. Dlatego tak istotną kwestią jest właściwy jego wybór zarówno pod względem efektownego wyglądu jak i wysokiej funkcjonalności. Nasi projektanci są w stanie Tobie pomóc! **Współpracujemy z biurem projektowym Marad Design**, które tworzy opakowania dopasowane do indywidualnych potrzeb i zastosowań. Nie ma znaczenia jak duży bądź mały jest Twój produkt - **jesteśmy w stanie wykonać dowolne, często bardzo niestandardowe opakowanie o pojemności od 5ml do 8 litrów**. Na każdym etapie projektu chętnie służymy poradą i zapewniamy konsultacje naszego działu technicznego.

### Packaging Design

You have a product which took a lot of time, attention and money to develop. The product is unique and special. And yet, **the first thing that will catch your customer's eye is the packaging**. Hence, it is so important to make the right choice, in terms of creating both a spectacular appearance and high functionality. Our designers can help you!

**We cooperate with design bureau Marad Design**, which develops packaging tailored to individual needs and purposes – no matter how big or small your product is, **we can even make completely non-standard packaging in capacity ranges of 5 ml - 8l**. At every stage of the design, we provide the advice and assistance of our technical department.



## **P.P.H.U. POLIPACK s.j.**

ul. Słoneczna 36

84-241 Gościcino, Polska

tel.:+48 58 572 02 02

tel.:+48 58 572 02 04

fax: +48 58 572 02 03

[www.polipack.com.pl](http://www.polipack.com.pl)

[polipack@polipack.eu](mailto:polipack@polipack.eu)

